

42" ROTARY MOWER MODEL AA42

INSTRUCTIONS

The AA42R Rotary Mower is supplied with a KR42 Rear Discharge Kit, and the AA42S mower includes the KS42 Side Discharge Kit.

The Rear Discharge Kit is recommended for the homeowner who mows his lawn frequently or intends to use the Elec-Trak sweeper (AS31). A greater degree of safety is afforded the operator and bystanders with this kit since objects that are picked up by the blades are discharged under and behind the tractor.

The Side Discharge Kit is designed for those homeowners who mow their lawns less frequently without picking up the grass clippings. The side discharge arrangement disperses the clippings over a wider area.

WARNING: Side discharge mowers should not be used near bystanders or buildings where a thrown object could cause injury.

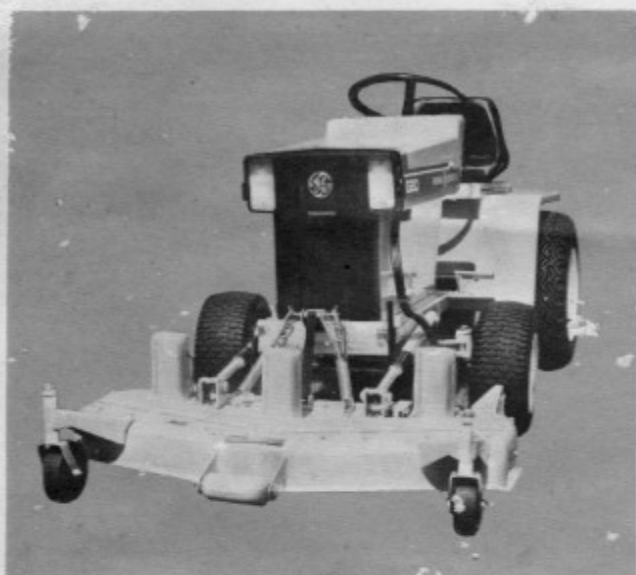

Figure 1

In either configuration, the mower is mounted directly to the Elec-Trak tractor without the need of additional equipment. (See Figure 1.)

INSTALLATION

The addition of adjustable helper springs and mower arm wear sleeves to the AA42 Rotary Mower is performed as follows:

HELPER SPRINGS

The helper springs must be assembled before initial installation by attaching a three-link chain to the closed "eye" of each spring with an "S" hook. After the assembly is installed, the "S" hook ends should be closed to prevent disassembly when the mower is raised. (See Figure 2.) The method of installation and adjustment of these springs is given in the Owner's Use and Care instructions.

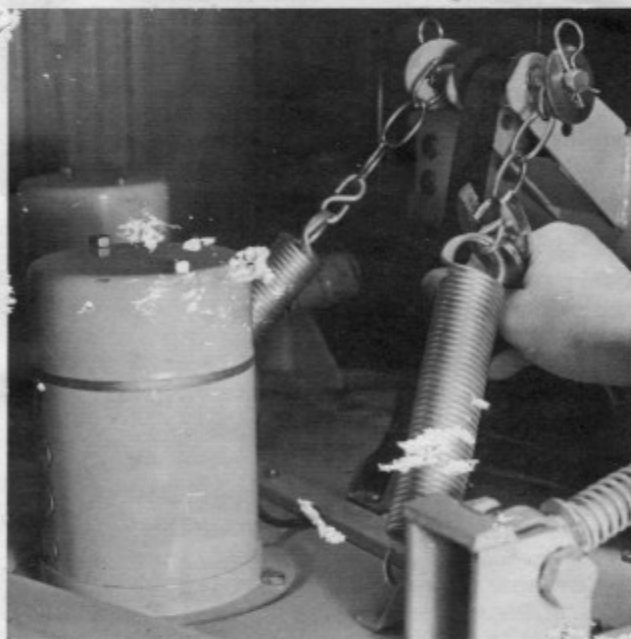

Figure 2

MOWER ARM WEAR SLEEVES

The mower arm wear sleeves are positioned on each mower mounting arm to prevent wear to the arms where they contact the front mower guide.

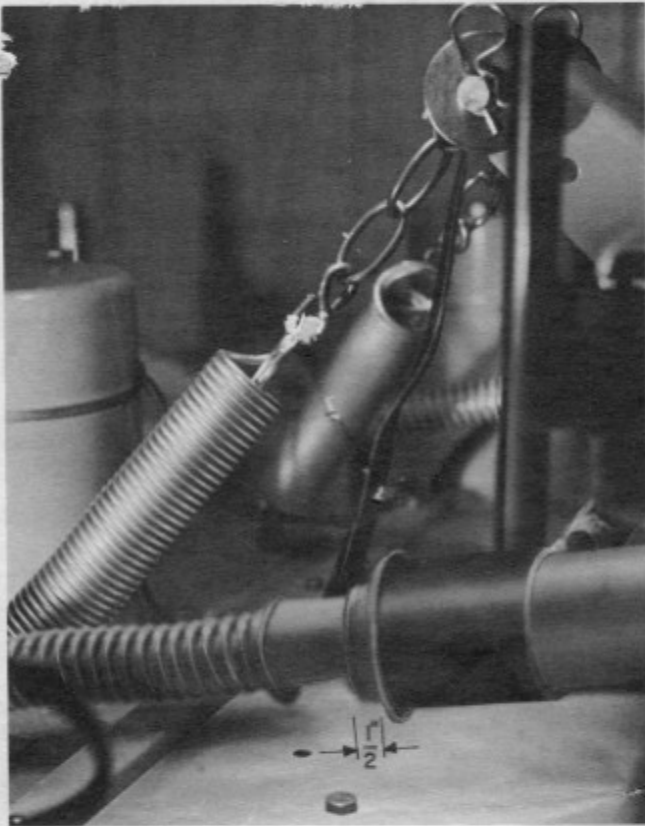

Figure 3

Refer to Figure 3, and install one large retaining ring on each arm 1/2-inch from the lower end of the main tube of the arm. This is easily done by marking the tube at the 1/2-inch point and pushing the ring over the tube with pliers while the arm is mounted to the tractor. The arm should then be temporarily removed from the tractor and one sleeve pushed over the main tube to the ring on each arm.

Each replacement mower wear sleeve carries the Part Number 244A7215P1.

FRONT MOWER GUIDE

The front mower guide eliminates any side motion of the mower arms. This improves stability and control in trimming around trees and shrubs. It also provides a bearing for the mower housing when raised for transportation or for mowing high grass.

The front mower guide is installed on the front of the tractor with its roller nearest the ground. The two rectangular tabs on each side of the mower guide are inserted in the frame slots on

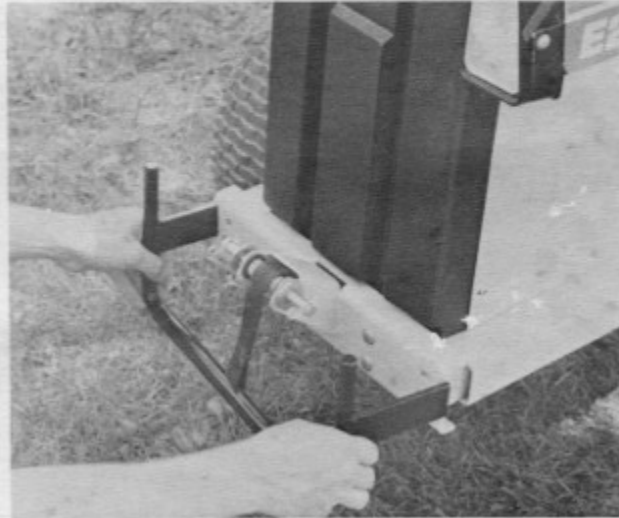

Figure 4

each side of the bumper. See Fig. 4) For ease of assembly, insert one tab approximately 1/2-inch into a slot and push sideways on the opposite tab to slide it up with the other slot. Then, push the mower bumper in against the bumper.

Remove the upper right carriage bolt from the bumper and pass it through one of the clamps supplied so when the bolt is reinstalled, the clamp holds the mower guide in place. Install another clamp on the upper left bumper carriage bolt in the same way. (See Figure 5.)

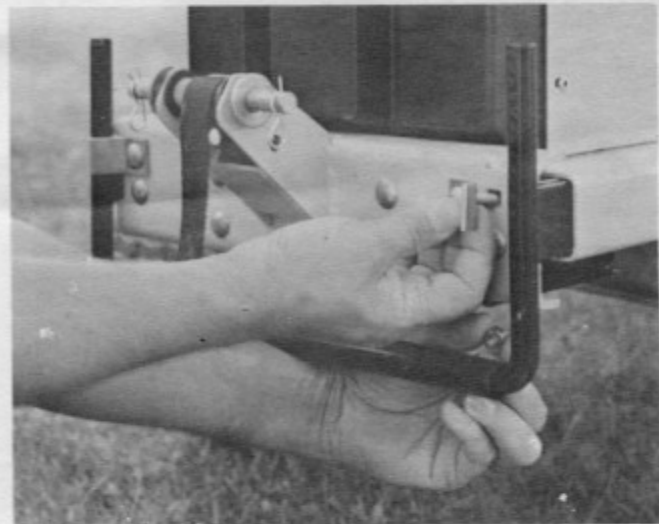

Figure 5

MOWER ATTACHMENT

To attach the mower, refer to Figure 4 and take the following steps:

1. Center the mower in front of the tractor with the mounting arms rearward in the approximate mounting position.
2. Secure the mounting arms to the tractor frame with the clevis pins and hair pin cotters supplied with the tractor. (See insert Fig. 6.) Installation is eased by pushing the clevis pin back in flush to the frame side, then lining up the hole in the mower arm and pushing the pin through the arm.
3. Thread the lift strap under the lower guide roller (a) and over the front guide roller

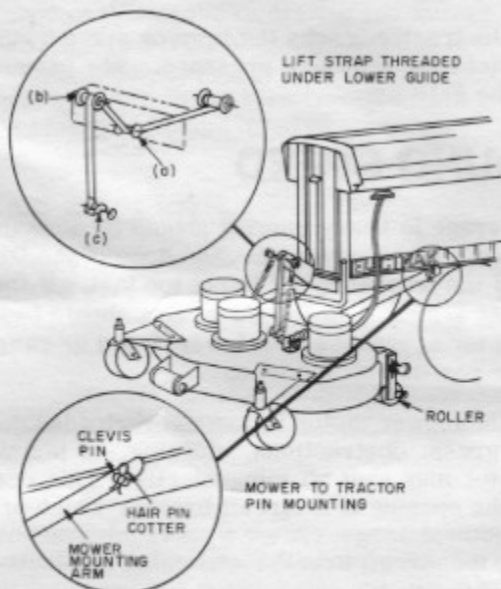

Figure 6

- (b) as shown in the insert Fig. 6. Attach it to the mower lift clevis pin (c).
4. Lift the mower to its raised position and attach mower "helper" springs to either side of the front lift-guide axle using similar links on each chain extension. Secure with washers and hair pin cotters (See Figure 7). For normal conditions, the upper or center links should be used. If side hills are to be mowed, best results may be obtained using the lower links. This applies more of the mower weight to the front tractor wheels and permits better steering control.
 5. Lower the mower to the ground and allow slack in the lift strap. (The lift strap should have extra slack when the mower is

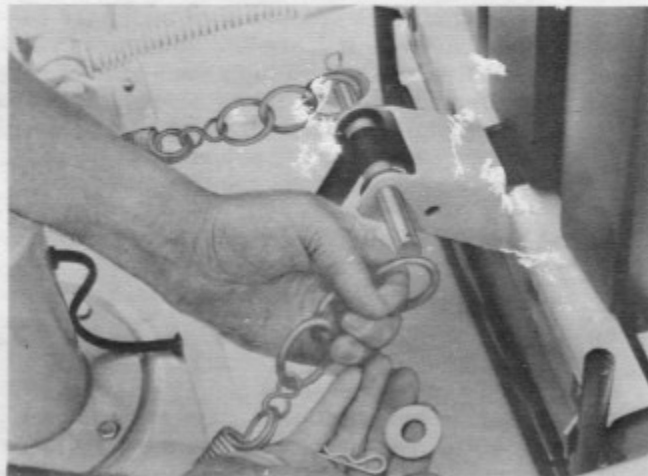

Figure 7

used on hilly terrain so the mower can follow the uneven terrain.)

6. Stand clear of the mower and insert the power cord plug into the tractor PTO receptacle.

Removal of the mower follows the same steps in the reverse order.

WARNING: Never handle the mower or make adjustments while the power cord is plugged into the PTO receptacle.

ADJUSTMENTS

The cutting height of the mower may be adjusted from 1 1/2-inches to 4-inches in 1/2-inch increments. Height adjustment is made as follows:

1. Remove the power cord from the PTO receptacle.
2. Raise the mower by the lift to its "Up" position.
3. Hold one of the front casters and remove its retaining pin.
4. Slide the caster downward free of the support.
5. Reassemble the caster with the desired number of 1/2-inch spacers below the support and the remaining spacers above the support. Secure with the plain washer and spring pin and adjust the other caster similarly.
6. Adjust the rear roller at each end. The number of holes on the roller adjuster above the guide pin should correspond to

the number of spacers used under the caster support. If there are no spacers below (all five spacers on top), each side of the roller adjuster should be secured in the top guide pin hole. Using one spacer below the support requires the adjusters to be set in the second hole from the top, and so on.

MOWER OPERATION

The operator must be seated on the tractor and the key switch turned to "On" before the PTO switch can be turned "On" to start the mower. An electrical interlock prevents mower starting if this procedure is not followed. Once the mower is running, if the operator leaves the seat, or turns the key switch to "Off," another interlock operates which not only interrupts mower power, but also stops blade rotation immediately by a dynamic braking action. To restart, the starting procedure must be repeated. For all normal use, the PTO switch should be used to turn the mower on and off.

For maximum drive motor torque and most efficient use of power, the speed control should be maintained in the recommended position whenever possible. Advancing the speed lever (or pedal) increases the speed on normal terrain, but may cause decreased speed when going uphill, because the motor torque is reduced. The D1 range is best for average to heavy mowing, and D2 may be used for lighter duty, faster mowing.

When mowing on steep hillsides, the travel should be up and down.

WARNING: Care should be exercised to avoid sudden starts and stops, which may cause loss of control. The tractor motor will offer some braking action provided the speed control is not returned to neutral. Maximum braking is obtained with the speed control in the drive position, or cruise control. Whenever operation on hillsides is required, the rear tractor wheels should be assembled in the "wide-tread" position for increased stability. (Refer to your tractor Use and Care Manual.)

CUTTING

Always mow with sharp blades. The blades can be sharpened in place on the Elec-Trak mower. Always disconnect the power cord before working on the mower. After several sharpenings the blades should be checked for balance. Unbalanced blades can shorten the life of the mower motor bearings.

For good appearance of the mowed lawn, it is important to have the mower adjusted correctly for height of cut. (See section on Adjustments.) Unequal adjustments can affect the cutting appearance because the blades will not be level.

After determining that the mower is set for level mowing as described above, the best height of cut should be determined. It is suggested that the use of two spacers below the caster support be tried first. Closer cutting can be obtained with fewer spacers, but care must be used not to scalp uneven parts of the lawn. As the cutting height is increased to more than 2 spacers, some types of grass and turf may begin to show the wheel tracks where the grass is long enough to be rolled down and not spring back up.

If the tractor tracks the lawn or gives a bumpy ride, check the rear tire pressure. The pressure should be 8-10 psi.

GROUND SPEED

Average to heavy mowing should be done in the D1 range. Light mowing may be done in the D2 range if the tractor speed is not too fast. If the cut is not even and clean, the blades should be checked for sharpness or a lower speed or range selector position should be used.

If the mower motor becomes overloaded due to high grass, obstructions, clogging, or jamming, that motor may shut off momentarily. This occurs due to the opening of a circuit breaker which prevents motor damage. After a short interval for cooling, the circuit breaker will reset automatically and the motor will restart. If the breaker continues to interrupt motor power, after loading has been reduced, remove the power cord from the PTO receptacle and check the blades for clogged grass.

CLEANING

It is recommended that the mower deck be cleaned after each use to maintain maximum mowing effectiveness and reduce the likelihood of blade clogging. Immediately after each use, expose the underside of the mower by lowering the mower, removing the power cord from the PTO receptacle, and picking up the front edge of the mower using the handle. When positioned properly, the mower will stand freely in a nearly vertical position. In this position, cleaning is easily done by scraping the grass from the mower housing.

WARNING: Always disconnect power cord from PTO receptacle before handling the mower for any reason.

